



Features :

- Universal AC input / Full range (up to 295VAC)
- Protections: Short circuit / Over current / Over voltage / Over temperature
- Output voltage and constant current level adjustable
- Built-in active PFC function
- IP66 design for indoor or outdoor installations
- Cooling by free air convection
- 100% full load burn-in test
- High reliability
- Suitable for LED lighting and moving sign applications
- Compliance to worldwide safety regulations for lighting
- Suitable for dry / damp / wet locations
- 3 years warranty

SPECIFICATION



MODEL	CEN-60-12	CEN-60-15	CEN-60-20	CEN-60-24	CEN-60-30	CEN-60-36	CEN-60-42	CEN-60-48	CEN-60-54	
OUTPUT	DC VOLTAGE	12V	15V	20V	24V	30V	36V	42V	48V	54V
	CONSTANT CURRENT OPERATION VOLTAGE Note.5	9 ~ 12V	11.25 ~ 15V	15 ~ 20V	18 ~ 24V	22.5 ~ 30V	27 ~ 36V	31.5 ~ 42V	36 ~ 48V	40.5 ~ 54V
	RATED CURRENT	5A	4A	3A	2.5A	2A	1.7A	1.45A	1.3A	1.15A
	CURRENT RANGE	0 ~ 5A	0 ~ 4A	0 ~ 3A	0 ~ 2.5A	0 ~ 2A	0 ~ 1.7A	0 ~ 1.45A	0 ~ 1.3A	0 ~ 1.15A
	RATED POWER	60W	60W	60W	60W	60W	61.2W	60.9W	62.4W	62.1W
	RIPPLE & NOISE (max.) Note.2	2Vp-p	2.4Vp-p	1.8Vp-p	2.4Vp-p	3Vp-p	3.6Vp-p	4Vp-p	4.6Vp-p	5Vp-p
	VOLTAGE ADJ. RANGE (SVR1)	10.8 ~ 13.5V	13.5 ~ 17V	17 ~ 22V	22 ~ 27V	27 ~ 33V	33 ~ 40V	37 ~ 46V	43 ~ 53V	49 ~ 58V
	CURRENT ADJ. RANGE (SVR2)	3.75 ~ 5A	3 ~ 4A	2.3 ~ 3A	1.9 ~ 2.5A	1.5 ~ 2A	1.3 ~ 1.7A	1.1 ~ 1.45A	1 ~ 1.3A	0.9 ~ 1.15A
	VOLTAGE TOLERANCE Note.3	±10%								
	LINE REGULATION	±3.0%								
LOAD REGULATION	±5.0%									
SETUP TIME	1400ms / 230VAC 2800ms / 115VAC at full load									
INPUT	VOLTAGE RANGE Note.4	90 ~ 295VAC		127 ~ 417VDC						
	FREQUENCY RANGE	47 ~ 63Hz								
	POWER FACTOR (Typ.)	PF>0.97/115VAC, PF>0.95/230VAC, PF>0.9/277VAC at full load (Please refer to "Power Factor Characteristic" curve)								
	EFFICIENCY (Typ.)	86%	87%	88%	89%	90%	90%	90%	91%	91%
	AC CURRENT (Typ.)	0.8A/115VAC		0.4A/230VAC						
	INRUSH CURRENT (Typ.)	45A/230VAC								
LEAKAGE CURRENT	<0.75mA / 240VAC									
PROTECTION	OVER CURRENT	95 ~ 110%								
	SHORT CIRCUIT	Protection type : Constant current limiting, recovers automatically after fault condition is removed								
	OVER VOLTAGE	14.5 ~ 17V	17.5 ~ 21V	22.8 ~ 26V	28 ~ 34V	34 ~ 38V	41 ~ 46V	47 ~ 52V	54 ~ 60V	59 ~ 65V
	OVER TEMPERATURE	85°C ±10°C (RTH1)								
ENVIRONMENT	WORKING TEMP.	-30 ~ +70°C (Refer to "Derating Curve")								
	WORKING HUMIDITY	20 ~ 95% RH non-condensing								
	STORAGE TEMP., HUMIDITY	-40 ~ +80°C, 10 ~ 95% RH								
	TEMP. COEFFICIENT	±0.03%/°C (0 ~ 50°C)								
	VIBRATION	10 ~ 500Hz, 5G 12min./1cycle, period for 72min. each along X, Y, Z axes								
SAFETY & EMC	SAFETY STANDARDS	UL879, UL8750, TUV EN61347-1, EN61347-2-13, J61347-1, J61347-2-13, IP66 approved								
	WITHSTAND VOLTAGE	I/P-O/P:3.75KVAC			I/P-FG:1.88KVAC			O/P-FG:0.5KVAC		
	ISOLATION RESISTANCE	I/P-O/P, I/P-FG, O/P-FG:100M Ohms / 500VDC / 25°C / 70% RH								
	EMC EMISSION	Compliance to EN55015, EN61000-3-2 Class C (≥75% load) ; EN61000-3-3								
	EMC IMMUNITY	Compliance to EN61000-4-2,3,4,5,6,8,11, EN55024, EN61547, light industry level (surge 4KV), criteria A								
OTHERS	MTBF	523.4Khrs min. MIL-HDBK-217F (25°C)								
	DIMENSION	183*62.5*40.5mm (L*W*H)								
	PACKING	0.56Kg;24pcs/14.4Kg/1.11CUFT								
NOTE	<ol style="list-style-type: none"> 1. All parameters NOT specially mentioned are measured at 230VAC input, rated load and 25°C of ambient temperature. 2. Ripple & noise are measured at 20MHz of bandwidth by using a 12" twisted pair-wire terminated with a 0.1uf & 47uf parallel capacitor. 3. Tolerance : includes set up tolerance, line regulation and load regulation. 4. Derating may be needed under low input voltage. Please check the static characteristics for more details. 5. Constant current operation region is within 75% ~100% rated output voltage. This is the suitable operation region for LED related applications, but please reconfirm special electrical requirements for some specific system design. 6. The power supply is considered as a component that will be operated in combination with final equipment. Since EMC performance will be affected by the complete installation, the final equipment manufacturers must re-qualify EMC Directive on the complete installation again. 7. Direct connecting to LEDs is suggested, but is not suitable for using additional drivers. 									

■ Mechanical Specification

Case No.993B Unit:mm

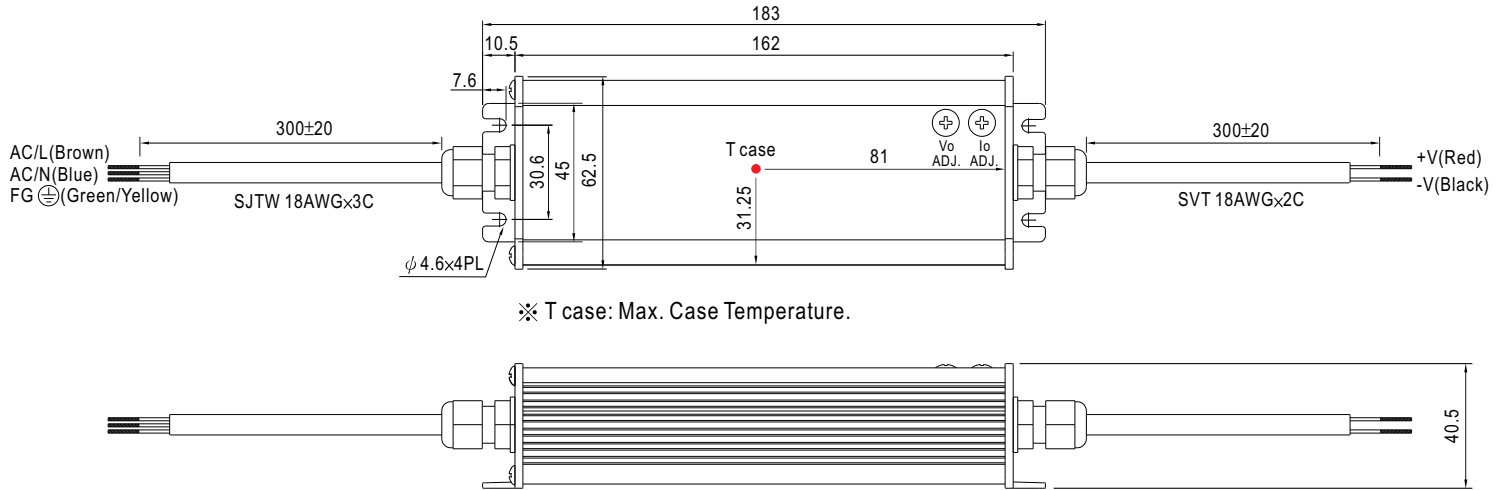

■ Block Diagram

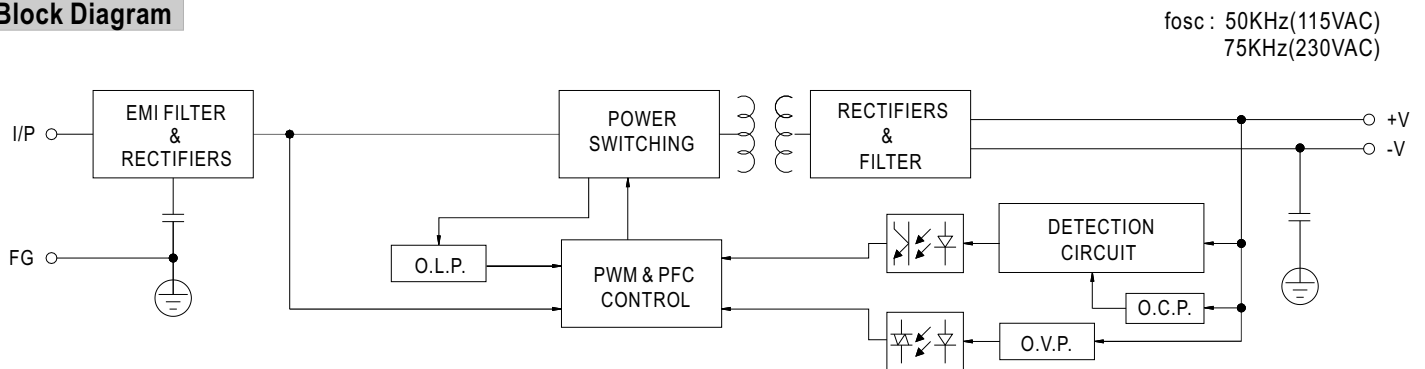

■ Derating Curve

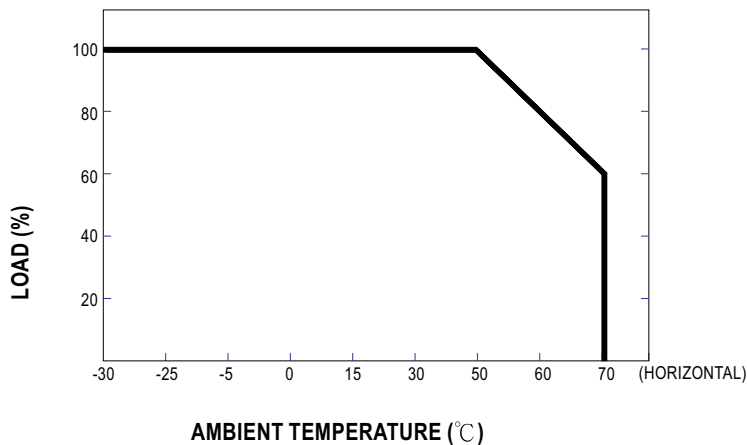

■ Static Characteristics

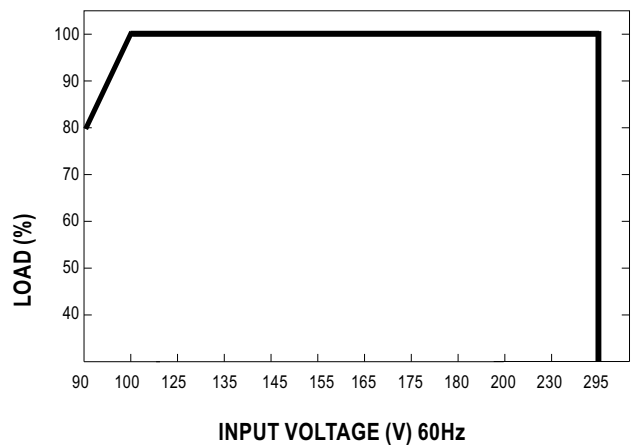

Power Factor Characteristic

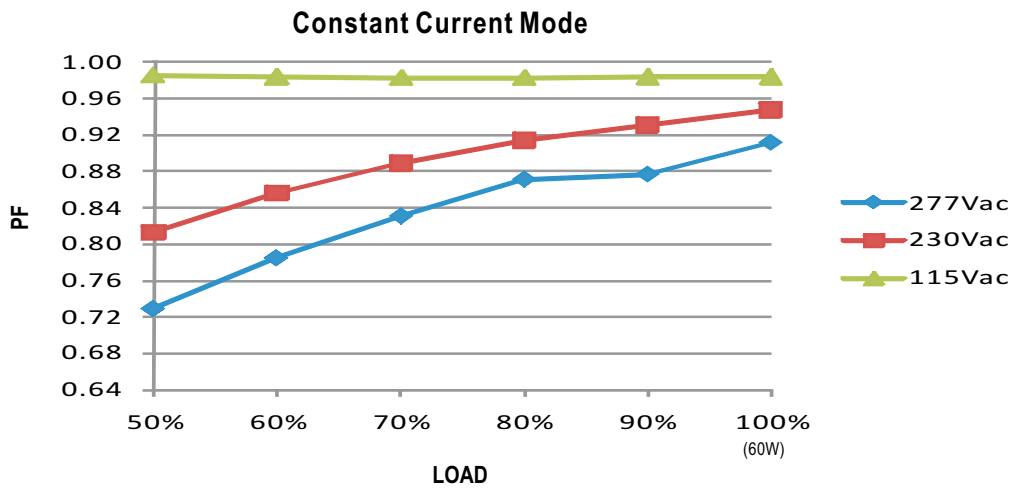

EFFICIENCY vs LOAD (48V Model)

CEN-60 series possess superior working efficiency that up to 91% can be reached in field applications.

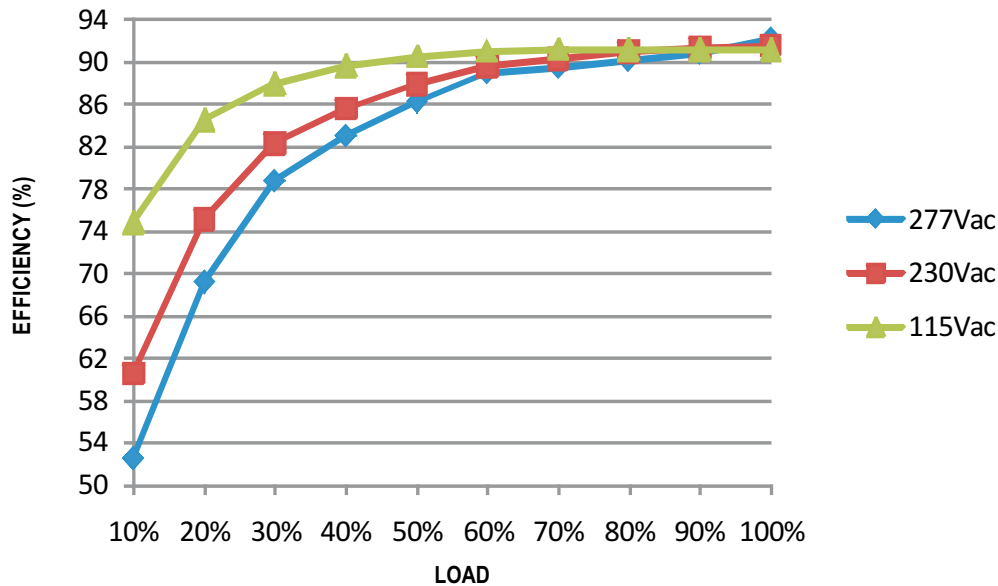

DRIVING METHODS OF LED MODULE

This LED power supply is suggested to work in constant current mode area (CC) to drive the LEDs.

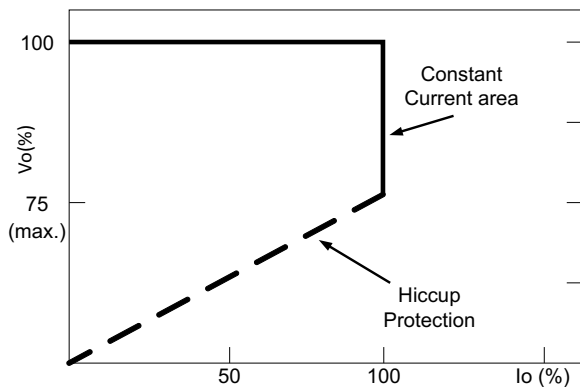

Typical LED power supply I-V curve